

组配角接触球轴承

72ACM/DT-7208ACM/DT

参数信息:

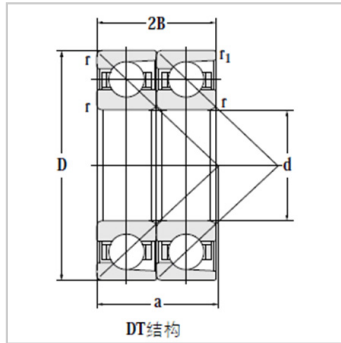

DT : 7208ACM/D
T

基本尺寸(mm) :

d : 40

D : 80

B : 36

额定负荷(kN) :

动负荷 : 59.9

静负荷 : 50.8

极限转速(rpm) :

脂润滑 : 5300

油润滑 : 7300

: